

AS-28
AT-28 Series

隱藏可拆鉸鏈 **Removable Concealed Hinges**

SUS304



AS-2810L

AT-2810LW

AT-2810RB

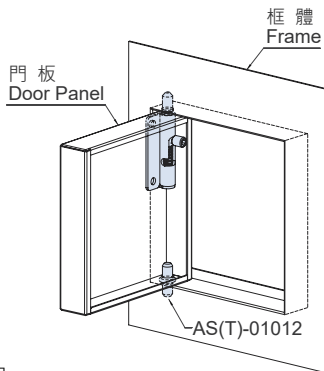

用途

- 門栓用。
- 鉸鏈用途，可運用在門板上下兩端可拆式用途。
- 選配-配件：T軸心 - AS(T)-01012

APPLICATION

- Latch use.
- Concealed, Removable Hinge.
- Optional accessory: T axial pin - AS(T)-01012.

AS-01012
AT-01012



配件-T軸心

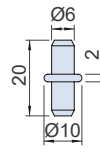

Accessory
T axial pin

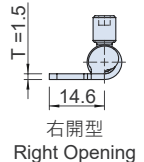
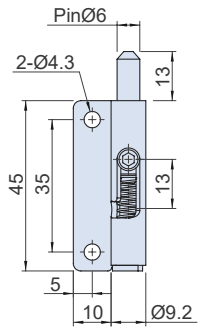
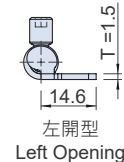
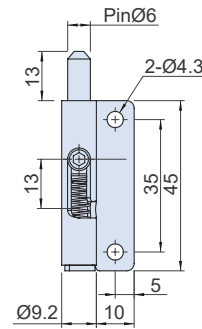

SPECIFICATIONS:

Unit:mm

產品編號 Item No.		配件 Accessories	材質 Material	表面處理 Finish		重量 Weight (g)
左開型 Left Opening	右開型 Right Opening					
AS-2810L	AS-2810R	含配件 With	SUS304	亮面	Vibration ground	31
AT-2810LW	AT-2810RW		SPCC	鍍鋅	Zinc plated	
AT-2810LB	AT-2810RB			黑色	Black coated	
AS-2810L-1	AS-2810R-1	不含配件 Without	SUS304	亮面	Vibration ground	26
AT-2810LW-1	AT-2810RW-1		SPCC	鍍鋅	Zinc plated	
AT-2810LB-1	AT-2810RB-1			黑色	Black coated	

AS-01
AT-01 Series

隱藏可拆鉸鏈 **Removable Concealed Hinges**

SUS304



AS-0101L
AT-0101L

AS-0101R
AT-0101R



AS-01012
AT-01012



配件-T軸心

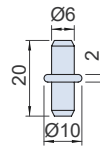

Accessory
T axial pin

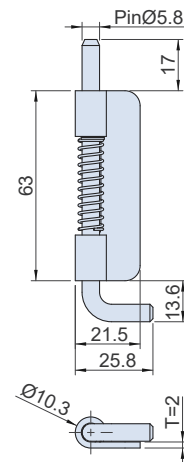

左開型
Left Opening

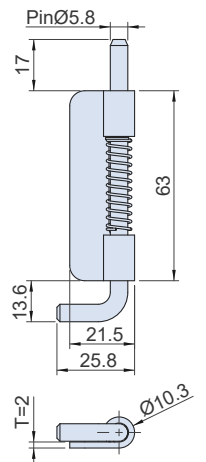

右開型
Right Opening

用途

- 門栓用。
- 鉸鏈用途，可運用在門板上下兩端可拆式用途。
- 選配-配件：T軸心 - AS(T)-01012

APPLICATION

- Latch use.
- Concealed, Removable Hinge.
- Optional accessory: T axial pin - AS(T)-01012.

SPECIFICATIONS:

Unit:mm

產品編號 Item No.		配件 Accessories	材質 Material	表面處理 Finish		重量 Weight (g)
左開型 Left Opening	右開型 Right Opening					
AS-0101L	AS-0101R	含配件 With	SUS304	亮面	Vibration ground	54
AT-0101L	AT-0101R		SPCC	鍍鋅	Zinc plated	
AS-0101L-1	AS-0101R-1	不含配件 Without	SUS304	亮面	Vibration ground	49
AT-0101L-1	AT-0101R-1		SPCC	鍍鋅	Zinc plated	